

# ENERGIZER E91

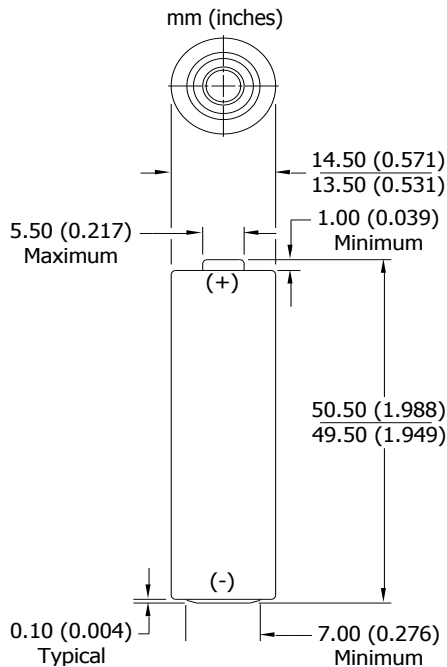

## Industry Standard Dimensions



## Specifications

<b>Classification:</b>	Alkaline
<b>Chemical System:</b>	Zinc-Manganese Dioxide (Zn/MnO <sub>2</sub> ) No added mercury or cadmium
<b>Designation:</b>	IEC-LR6
<b>Nominal Voltage:</b>	1.5 volts
<b>Nominal IR:</b>	150 to 300 milliohms (fresh)
<b>Operating Temp:</b>	-18°C to 55°C
<b>Typical Weight:</b>	23.0 grams
<b>Typical Volume:</b>	8.1 cubic centimeters
<b>Jacket:</b>	Plastic Label
<b>Shelf Life:</b>	10 years at 21°C
<b>Terminal:</b>	Flat Contact

## Milliamp-Hours Capacity

Continuous discharge to 0.8 volts at 21°C

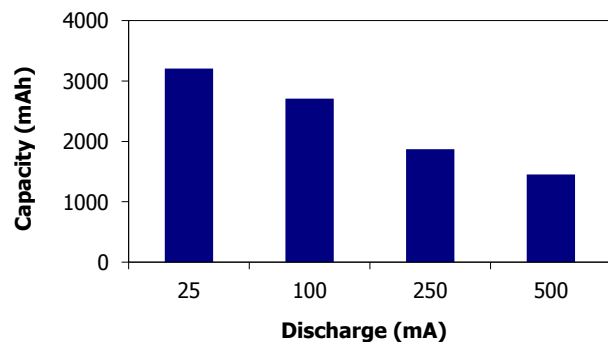

## Constant Power Performance

Typical Characteristics (21°C) to 0.8 Volts

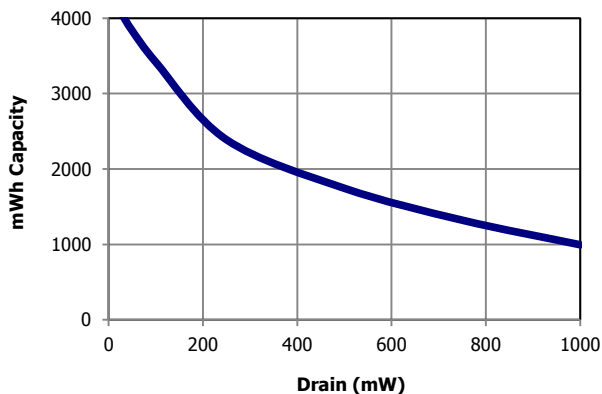

## Constant Current Performance

Typical Characteristics (21°C) to 0.8 Volts

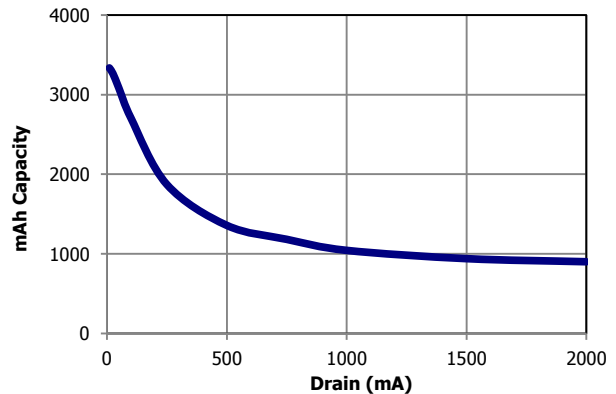

### Important Notice

This data sheet contains typical information specific to products manufactured at the time of its publication. Physical values are for reference purposes and not intended for specific calculations.

©Energizer Brands, LLC - Contents herein do not constitute a warranty.

**ENERGIZER E91**



**Constant Power Performance**

Typical Characteristics (21°C)

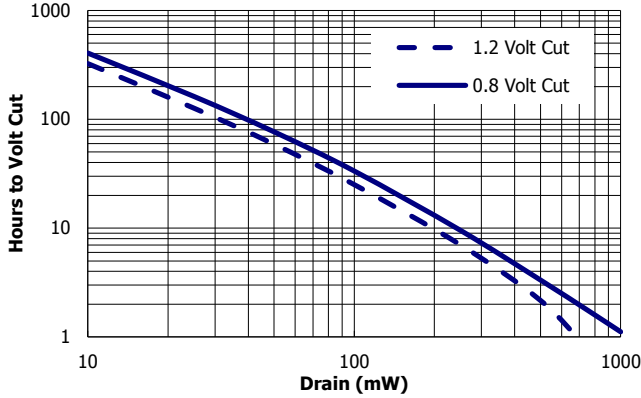

**Constant Current Performance**

Typical Characteristics (21°C)

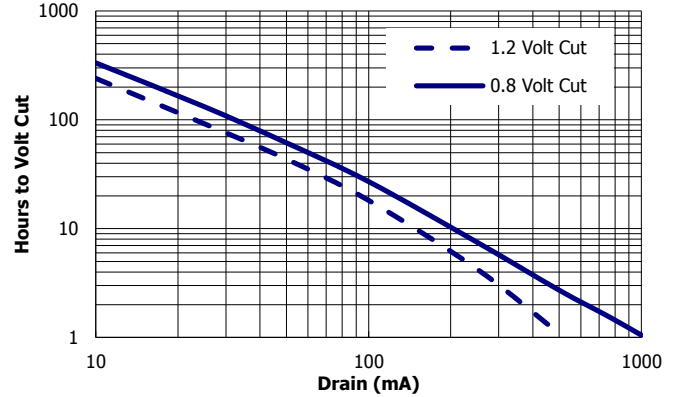

**Industry Standard Tests (21°C)**

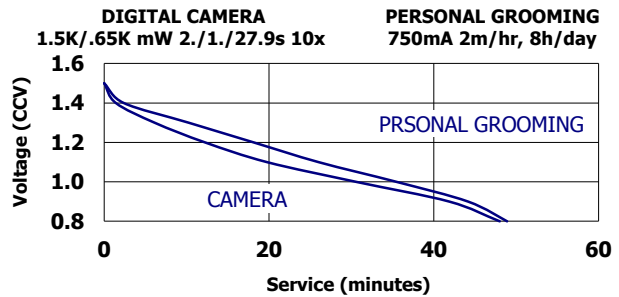
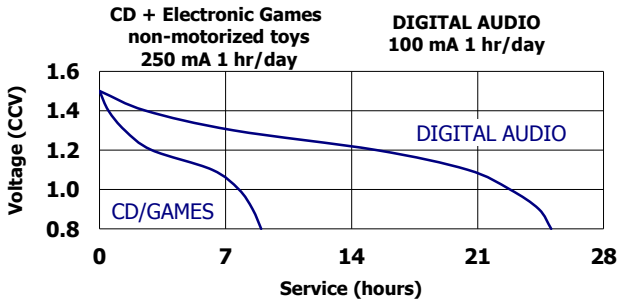
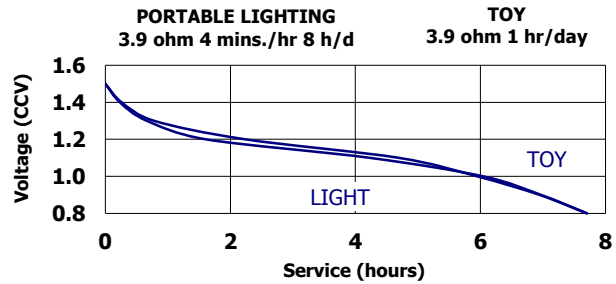
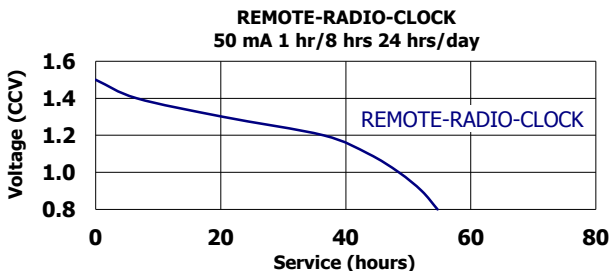

**Important Notice**

This data sheet contains typical information specific to products manufactured at the time of its publication. Physical values are for reference purposes and not intended for specific calculations.  
©Energizer Brands, LLC - Contents herein do not constitute a warranty.